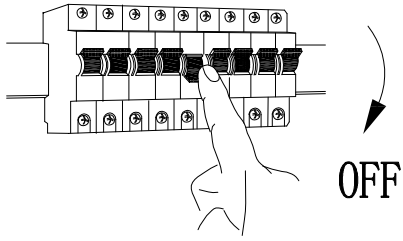
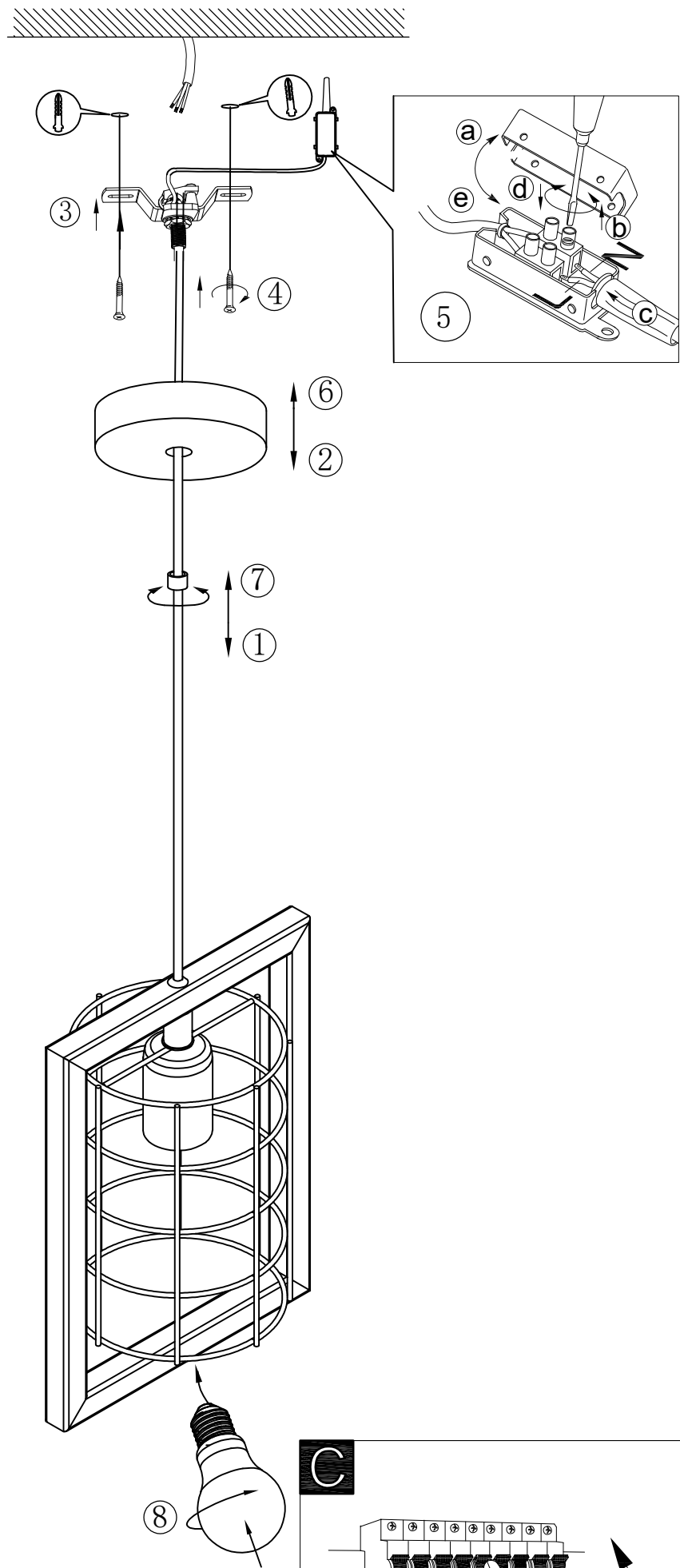
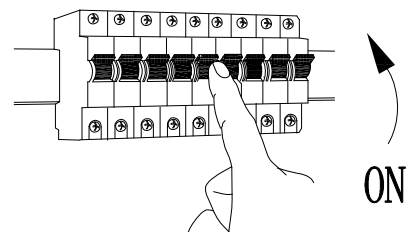

**A****B****C**

BLA43662  
www.eglo.com